

Light Commercial Air Conditioner



www.jet-air.co.za

Due to **JASA** policy of constant improvement, specifications are subject to change without prior notice.

Copyright© JASA. All rights reserved.

E.&O.E.

Proudly distributed by

JASA
Smart Home

Johannesburg (011)708 1148
Pretoria (012)752 8777
East Rand (011)823 2119
Cape Town (021)823 8866

Durban (031)577 0498
Nelspruit (013)752 3258
Port Elizabeth (041)364 0947
Botswana (00267)262 2909

Jet-Air
Cool, Warm & Collected



Jet-Air Light Commercial

Jet-Air Light Commercial air conditioners fall between residential air conditioners and central air conditioners. Their capacity scope is wider than that of residential air conditioners: from 12KBtu/h to 60KBtu/h. Indoor units of floor ceiling type, duct type and cassette type are available. Their installation is simpler than that of conventional central air conditioners, with low installation cost and no need of welding. They are well suited to the areas from 16m² to 140m², such as apartments, villas, hotels and offices.



1 More Convenient & Comfortable

Multiple Temperature Displays

» Indoor set temperature, indoor ambient temperature and outdoor ambient temperature can be displayed. Meanwhile, the display of the three kinds of temperature can be switched freely through the remote controller or wired controller.

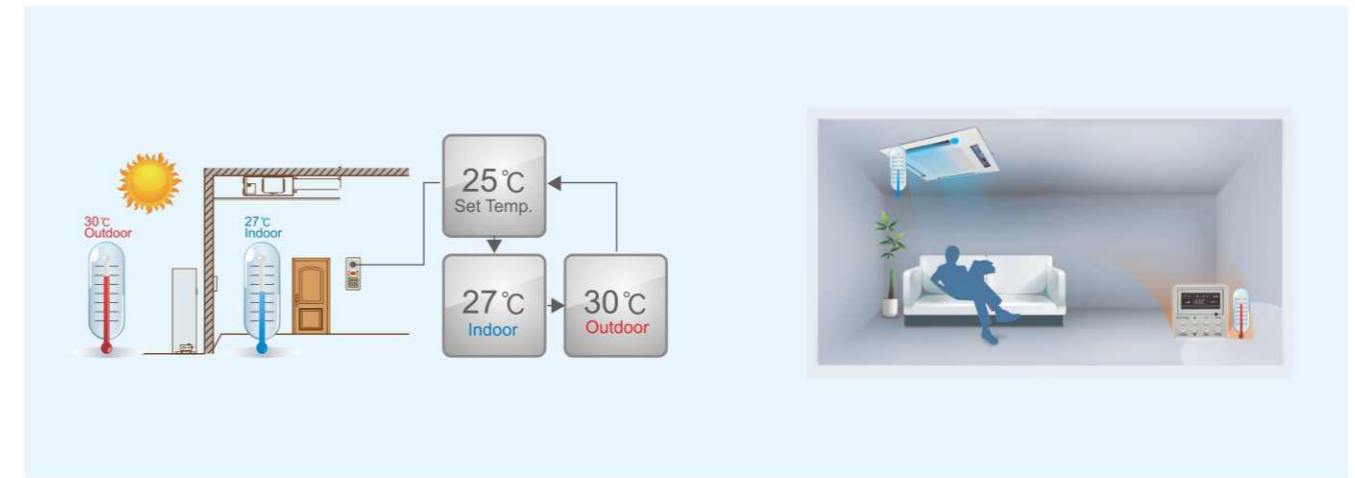

Setting Function of Indoor Dual Temperature Sensors

» In order to better control indoor ambient temperature and improve user's comfort, dual indoor temperature sensors have been designed. Indoor unit and wired controller are equipped with the temperature sensors. The unit will automatically start the suitable temperature sensors according to the mode.

Cold Air Prevention Function

» When the unit just starts heating or the outdoor unit just finishes defrosting, the temperature of indoor evaporator is quite low. If the indoor fan operates in this case, cold air will blow out. Our products are optimized in design to prevent cold air so as to improve user's comfort.

Power-off Memory Function

» The user can set power-off memory function. If this function is activated, the unit will automatically operate in previous setting mode when power recovers after power failure.

Water Full Protection (Optional)

» If the water cannot drain out properly for the failure of water pump or other causes, this function will be activated automatically and the unit will stop for protection when the water in the indoor unit reaches a certain level.

2 Air Handling Function

Mould Proof(X-FAN)

» Do you know that water in IDU will give birth to bacteria which will affect human health? Jet-Air Light Commercial will wipe out water, caring for your health!

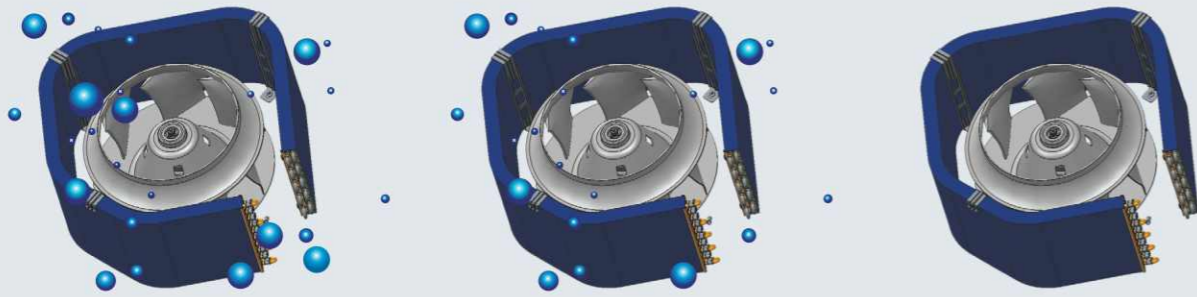

3 Safer & More Reliable

Intelligent Defrosting

» Did you ever feel annoyed when the air conditioner stopped heating because of defrosting? This problem has already been resolved by Jet-Air Light Commercial. Unit only starts defrosting when it's necessary, which is more energy-saving and comfortable.

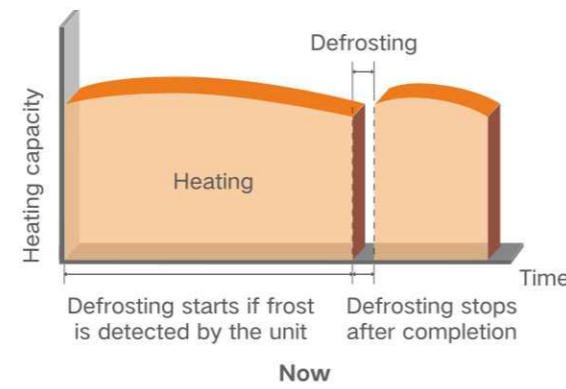
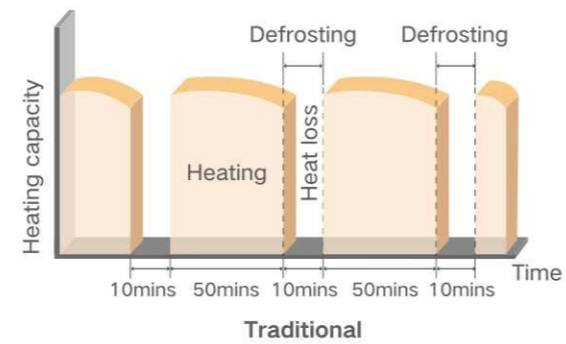

Antifreezing Protection

» If frost of outdoor condenser is detected by the unit, the compressor will stop for protection.

4 Centralized Control Function

Building Management System Interface (MODBUS Protocol) and Long-distance Monitoring

» If the unit is to be connected with the building management system, please consult Jet-Air for the development of MODBUS protocol. In this case, the unit operation information will be sent to the building management system in order to control and monitor the units.

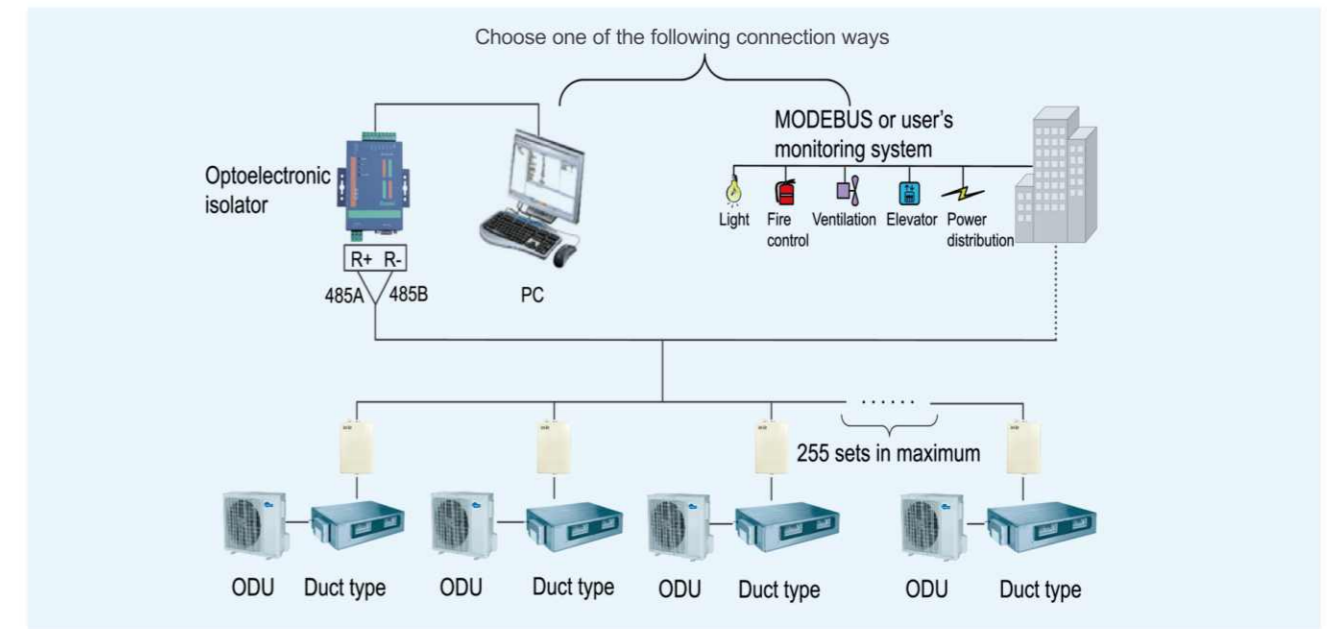

Centralized Control Function

The indoor unit is equipped with the interface that can be connected with Centralized Controller, in order to realize central control of 36 units in maximum without connecting wired controller. It can control the on/off, mode, fan speed, temperature setting and timer of a single unit or a group of units.

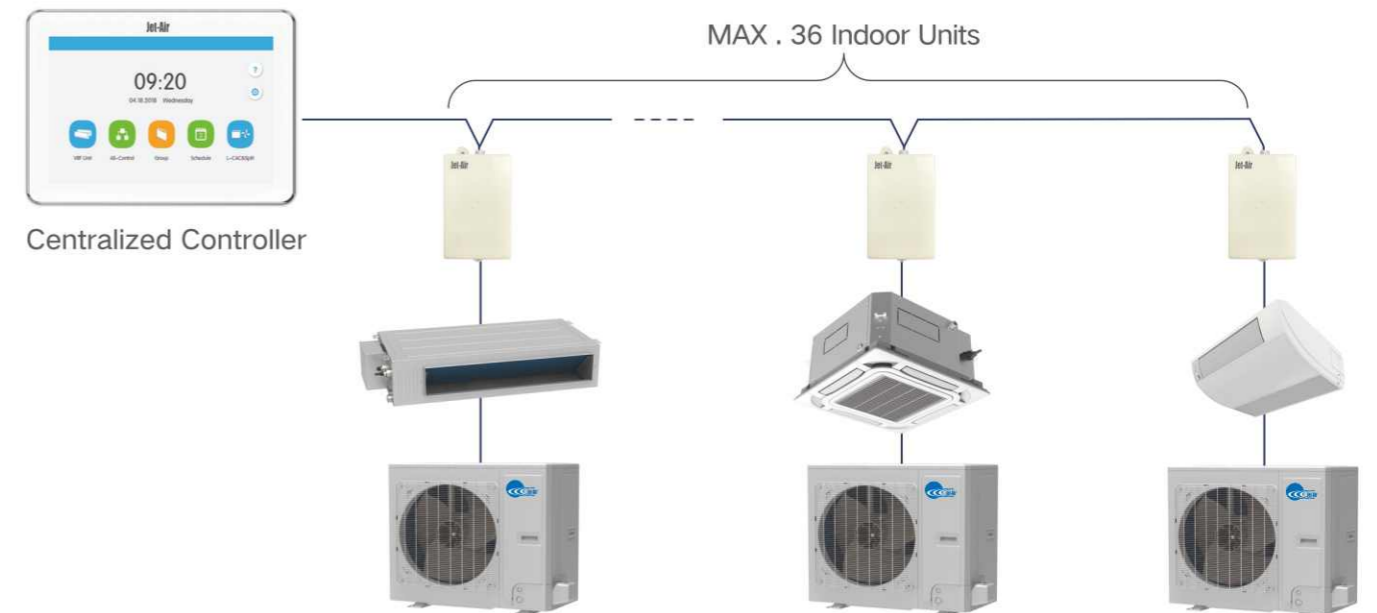

5 Introduction of Indoor Units

Duct Type Indoor Unit

» The static pressure can be adjusted within 0~150pa, applicable for various installation requirements.

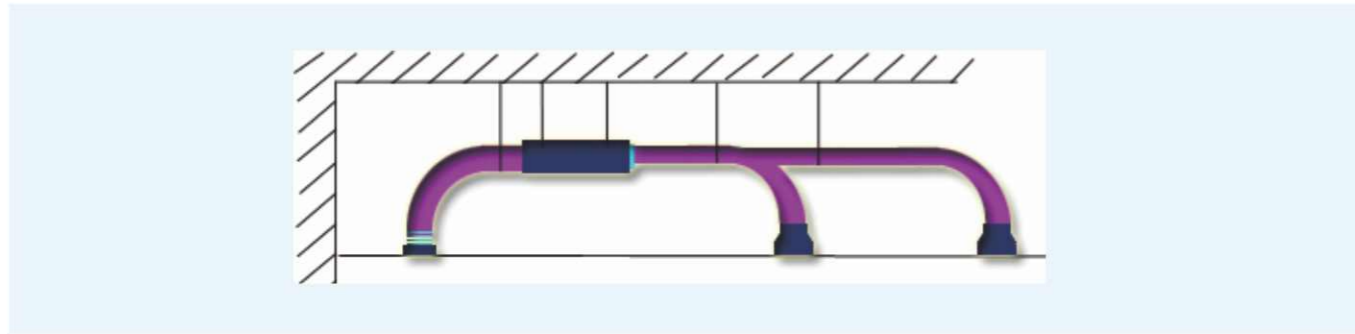

» Adjustable fan speed

Fan speed of indoor unit can be adjusted by wired controller and there are 4 kinds of speed (turbo, high, medium, low) to meet different requirements.

» Highly flexible installation

Highly flexible installation is possible to satisfy various needs.

» Flexible and easy to install in L shape, U shape and large rooms.

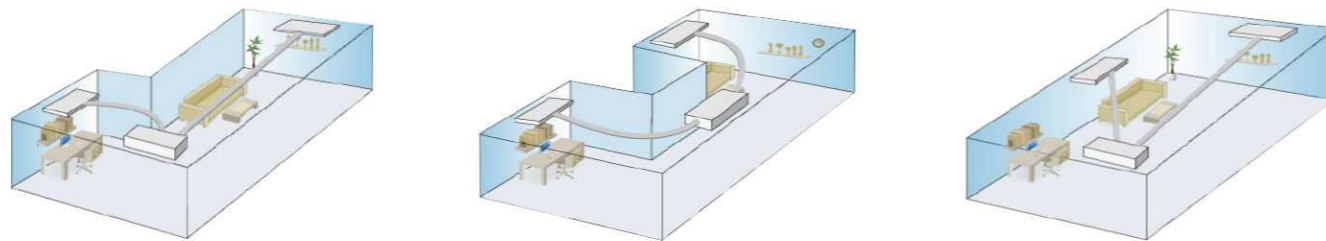

» Drain pump lift (Optional)

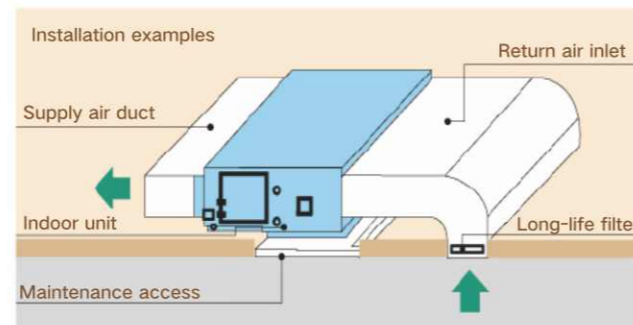
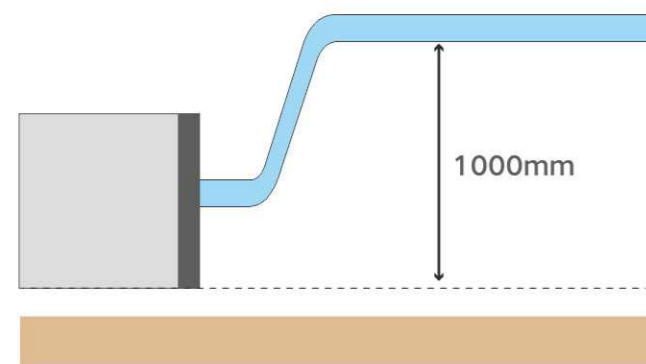

Cassette Type

» Low noise with 3-dimensional blade

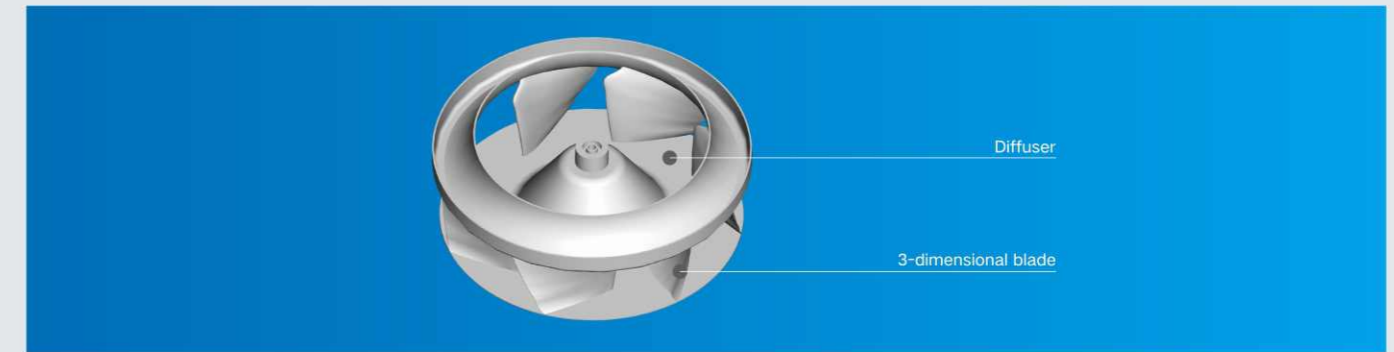

» High ceiling applications

24K~60K units are applicable to the height below 4.5m

» Units below 24K are applicable to the height below 3m.

» Comfortable airflow

Air supply in different directions with 30~60 degrees of swing angle for even temperature distribution.

» Water drainage pump

Drain pump fitted as standard with increased lift of 1000mm.

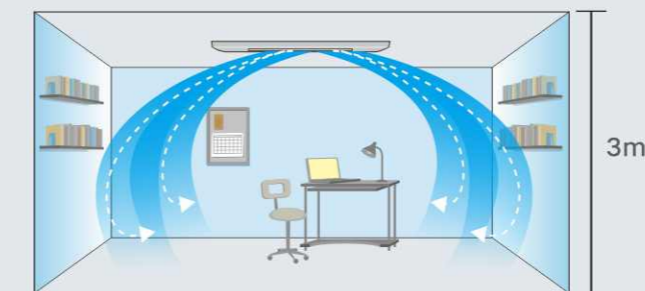
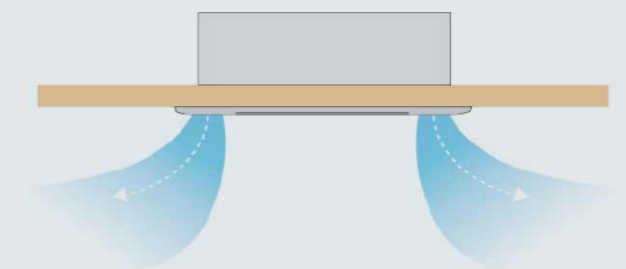
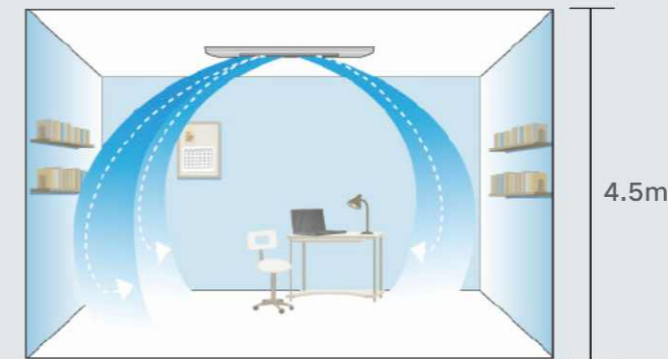



Floor Ceiling Type Indoor Unit

» Compact design

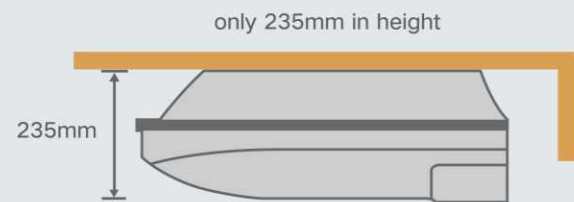

» Wide discharge range

With cross-direction swing angle, the air supply range is wider.

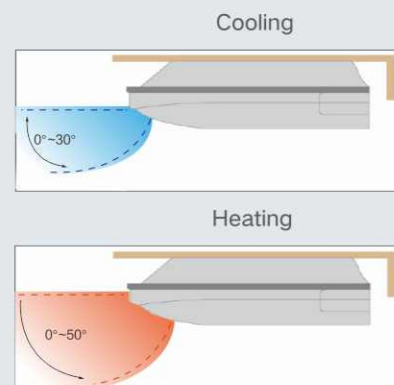

» Easy maintenance

Convenient disassembly and maintenance thanks to the unique design.

» Microcomputer control

The complete control functions are controlled by microcomputer which not only shows all running modes and temperatures but also has functions like malfunction diagnosis and data search.

» Flexible installation

There are 2 installation methods: installation on the ceiling or floor.



Ceiling Type

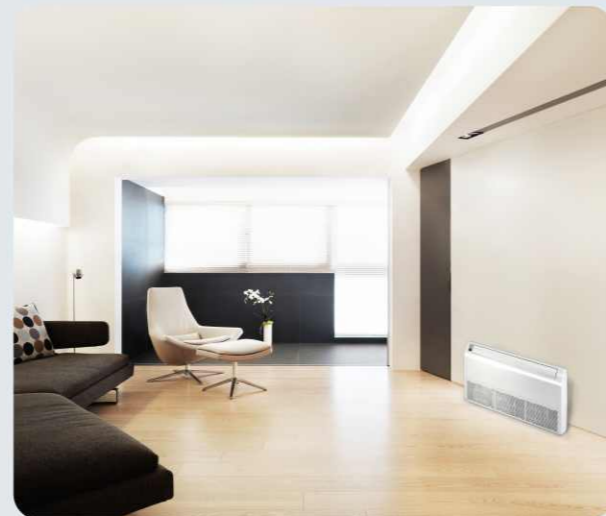

Floor Standing Type

Inverter Series

Cooling capacity is 3.5kW~16.0kW. The outdoor unit can be freely connected to duct type units, cassette type units and floor ceiling units.

High efficiency

All DC inverter technology

Compact design

Anti-cold function

Fresh air supply ventilation

Intelligent defrosting

Memory function

Easier maintainability

Turbo function

» Compact design; single fan design for the whole series; the maximum height is only 820mm.

» With fast cooling and heating functions.

» Connection pipe is 75m at the most.

» All DC inverter design.

Indoor Unit

Duct type

- » Wired controller can adjust the static pressure according to the engineering requirements.
- » Fresh air interface reserved.
- » Built-in water pump optional.
- » Ultra-thin structure design; the thinnest thickness is 200mm.
- » Supply air outlet and return air outlet are interchangeable, convenient for installation.

Cassette type

- » 360 ° air discharge panel.
- » DC motor and DC water pump, high-efficiency and energy-saving.
- » Water pump lift is up to 1000mm.
- » Only 570mm for 12K and 18K cassette unit.
- » Adopt fireproof electric box.

Floor ceiling type

- » DC motor, high-efficiency and energy-saving.
- » Fresh air interface reversed.
- » Three pipe outlet methods.
- » Dual air guide louvers and 3D air supply.
- » Metal electric box and fireproof design.

Item	Nominal operating condition (temperature)				Operating range (temperature)
	Outdoor condition		Indoor condition		Outdoor condition
	DB(°C)	WB(°C)	DB(°C)	WB(°C)	DB(°C)
Cooling	35	24	27	19	-15~48
Heating	7	6	20	15	-15~24

Units Lineup

Capacity index		35	50
Indoor unit	Outdoor unit		
	Duct		
	Cassette		
	Floor ceiling		

Capacity index		125	140	160
Indoor unit	Outdoor unit			
	Duct			
	Cassette			
	Floor ceiling			

Capacity index		71	100
Indoor unit	Outdoor unit		
	Duct		
	Cassette		
	Floor ceiling		

Specifications

Model	Outdoor unit		JASA-H12A4/ASI			
	Indoor unit		Duct	Cassette	Floor ceiling	
		JASA-Hi-H12A4/ASI		JASA-Ca-H12A4/ASI	JASA-Ce-H12A4/ASI	
Capacity	Cooling	kW	3.5	3.5	3.5	
		Btu/h	11900	11900	11900	
	Heating	kW	4.0	4.0	4.0	
		Btu/h	13600	13600	13600	
EER/COP		W/W	3.21/3.48	3.40/3.64	3.40/3.33	
Power supply		Ph/V/Hz	220-240V ~50/60Hz			
Power input	Cooling	kW	1.09	1.03	1.03	
	Heating	kW	1.15	1.1	1.2	
Current input	Cooling	A	4.75	4.45	4.45	
	Heating	A	5	4.8	5.2	
Refrigerant charge volume		kg	1			
Indoor unit	Air flow volume(SH/H/M/L)	CFM	383/353/300/265	382/341/282/235	383/359/312/271	
		m ³ /h	650/600/510/450	650/550/480/400	650/610/530/460	
	ESP	Rated	Pa	25	0	0
		Range	Pa	0-50	0	0
Sound pressure level (SH/H/M/L)		dB(A)	40/37/35/34	41/37/35/31	39/36/32/28	
	Dimension (W × D × H)	Outline	mm	700 × 450 × 200	570 × 570 × 265	870 × 665 × 235
Package		mm	1008 × 568 × 275	698 × 653 × 295	1033 × 770 × 300	
Net weight/Gross weight		kg	19/23	17/22	25/30	
Panel	Dimension (W × D × H)	Outline	mm	-	620 × 620 × 47.5	-
		Package	mm	-	701 × 701 × 125	-
	Net weight/Gross weight		kg	-	3.0/4.5	-
Outdoor unit	Sound pressure level	dB(A)	51	51	51	
	Dimension (W × D × H)	Outline	mm	818 × 302 × 596	818 × 302 × 596	818 × 302 × 596
		Package	mm	948 × 420 × 645	948 × 420 × 645	948 × 420 × 645
Net weight/Gross weight		kg	38/41	38/41	38/41	
Connection pipe	Outer diameter	Liquid	inch(mm)	Φ1/4(6.35)	Φ1/4(6.35)	Φ1/4(6.35)
		Gas	inch(mm)	Φ3/8(9.52)	Φ3/8(9.52)	Φ3/8(9.52)
	Max. distance	Height	m	15	15	15
		Length	m	30	30	30
Loading quantity	40'GP/40'HQ	unit	141/158	120/139	110/132	

Model	Outdoor unit			JASA-H18A4/ASI			
	Indoor unit			Duct	Cassette	Floor ceiling	
				JASA-Hi-H18A4/ASI	JASA-Ca-H18A4/ASI	JASA-Ce-H18A4/ASI	
Capacity	Cooling	kW		5.3	5	5.2	
		Btu/h		18000	17000	17700	
	Heating	kW		5.8	5.6	5.8	
		Btu/h		19700	19100	19700	
EER/COP		W/W		3.21/3.62	3.21/3.50	3.21/3.41	
Power supply		Ph/V/Hz		220-240V ~50/60Hz			
Power input	Cooling	kW		1.65	1.56	1.62	
	Heating	kW		1.6	1.6	1.7	
Current input	Cooling	A		7.4	6.78	7	
	Heating	A		7	7	7.4	
Refrigerant charge volume		kg		1.25			
Indoor unit	Air flow volume(SH/H/M/L)		CFM	559/518/500/441			
			m³/h	950/880/850/750			
	ESP	Rated	Pa	25			
		Range	Pa	0-50			
	Sound pressure level (SH/H/M/L)		dB(A)	40/39/37/35			
	Dimension (W × D × H)	Outline	mm	1000 × 450 × 200			
		Package	mm	1308 × 568 × 275			
	Net weight/Gross weight		kg	25/30			
Panel	Dimension (W × D × H)	Outline	mm	620 × 620 × 47.5			
		Package	mm	701 × 701 × 125			
	Net weight/Gross weight		kg	- / 3.0/4.5			
Sound pressure level		dB(A)	55				
Outdoor unit	Dimension (W × D × H)	Outline	mm	818 × 302 × 596			
		Package	mm	948 × 420 × 645			
	Net weight/Gross weight		kg	41/44			
Connection pipe	Outer diameter	Liquid	inch(mm)	Φ1/4(6.35)			
		Gas	inch(mm)	Φ1/2(12.7)			
	Max. distance	Height	m	20			
		Length	m	35			
Loading quantity	40'GP/40'HQ		unit	124/142		120/139	110/132

Model	Outdoor unit			JASA-H36A4/ASI			
	Indoor unit			Duct	Cassette	Floor ceiling	
				JASA-Hi-H36A4/ASI	JASA-Ca-H36A4/ASI	JASA-Ce-H36A4/ASI	
Capacity	Cooling	kW		10.1	10.1	10.0	
		Btu/h		34500	34500	34000	
	Heating	kW		11.0	11.0	11.0	
		Btu/h		37500	37500	37500	
EER/COP		W/W		2.97/3.44	2.97/3.67	2.94/3.44	
Power supply		V/Ph/Hz		220-240V ~50/60Hz			
Power input	Cooling	kW		3.4	3.4	3.4	
	Heating	kW		3.2	3.0	3.2	
Current input	Cooling	A		16.3	16.3	16.3	
	Heating	A		15.3	14.4	15.3	
Refrigerant charge volume		kg		2.45			
Indoor unit	Air flow volume(SH/H/M/L)		CFM	1059/942/824/706			
			m³/h	1800/1600/1400/1200			
	ESP	Rated	Pa	37			
		Range	Pa	0-150			
	Sound pressure level (SH/H/M/L)		dB(A)	43/41/39/37			
	Dimension (W × D × H)	Outline	mm	1000 × 700 × 300			
		Package	mm	1205 × 813 × 360			
	Net weight/Gross weight		kg	40/46			
Panel	Dimension (W × D × H)	Outline	mm	950 × 950 × 52			
		Package	mm	1033 × 1038 × 112			
	Net weight/Gross weight		kg	- / 6.0/9.5			
Sound pressure level		dB(A)	55				
Outdoor unit	Dimension (W × D × H)	Outline	mm	920 × 370 × 790			
		Package	mm	1083 × 488 × 855			
	Net weight/Gross weight		kg	61/66			
Connection pipe	Outer diameter	Liquid	inch(mm)	Φ3/8(9.52)			
		Gas	inch(mm)	Φ5/8(15.9)			
	Max. distance	Height	m	25			
		Length	m	50			
Loading quantity	40'GP/40'HQ		unit	68/80		58/69	72/85

Model	Outdoor unit			JASA-H24A4/ASI			
	Indoor unit			Duct	Cassette	Floor ceiling	
				JASA-Hi-H24A4/ASI	JASA-Ca-H24A4/ASI	JASA-Ce-H24A4/ASI	
Capacity	Cooling	kW		7.15	7.00	7.15	
		Btu/h		24300	23800	24300	
	Heating	kW		8	8	8	
		Btu/h		27200	27200	27200	
EER/COP		W/W		2.92/3.20	3.21/3.64	2.98/3.14	
Power supply		V/Ph/Hz		220-240V ~ 50/60Hz			
Power input	Cooling	kW		2.45	2.18	2.40	
	Heating	kW		2.50	2.20	2.55	
Current input	Cooling	A		10.65	9.47	10.43	
	Heating	A		10.87	9.56	11.09	
Refrigerant charge volume		kg		2			
Indoor unit	Air flow volume(SH/H/M/L)		CFM	617/588/529/470			
			m³/h	1050			
	ESP	Rated	Pa	25			
		Range	Pa	0-50			
	Sound pressure level (SH/H/M/L)		dB(A)	43/42/40/38			
	Dimension (W × D × H)	Outline	mm	1000 × 450 × 200			
		Package	mm	1308 × 568 × 275			
	Net weight/Gross weight		kg	25/30			
Panel	Dimension (W × D × H)	Outline	mm	950 × 950 × 52			
		Package	mm	1033 × 1038 × 112			
	Net weight/Gross weight		kg	- / 6.0/9.5			
Sound pressure level		dB(A)	55				
Outdoor unit	Dimension (W × D × H)	Outline	mm	892 × 340 × 698			
		Package	mm	1029 × 458 × 750			
	Net weight/Gross weight		kg	53/57			
Connection pipe	Outer diameter	Liquid	inch(mm)	Φ3/8(9.52)			
		Gas	inch(mm)	Φ5/8(15.9)			
	Max. distance	Height	m	25			
		Length	m	50			
Loading quantity	40'GP/40'HQ		unit	108/120		83/88	92/108

Control System Lineup

Control system	Product series	Duct type	Cassette type	Floor ceiling type
Wired controller	JASA-XK117 	●	○	○
	JASA-XE71-42/G 	○	○	○
Remote controller	JASA-YAW1F9 	○	○	○
	JASA-YAP1F6 	○	●	●
WiFi module (G-Cloud) ^{*2}	JASA-ME31C4 JASA-ME31C6 	○	○	○
MODBUS gateway	JASA-ME50-00 	○	○	○
Centralized controller (up to 36 indoor units)	JASA-CE52-24 	○	○	○
Dry contact gateway ^{*3} (extended function board)	JASA-ME30-42 	○	○	○
Door controller	JASA-MK03 	○	○	○
BACnet gateway	JASA-ME30-44/D2 	○	○	○

Note:

● means standard, ○ means optional.

*1 : Controller(cooling only)

*2 : Please contact the sales representative for WiFi module selection.

*3 : Function: ON/OFF input control, emergency stop input, error output, cold plasma control, fresh air control.



Big Duct Type Unit

Unit capacity: 20-60kW, suitable for a variety of installation occasions.

Operation range: -7~48°C for cooling and -15~24°C for heating.

Powerful cooling and heating capacity, convenient for installation and easy for after-sales service.

Applicable for large space areas, such as hotels, restaurants, meeting rooms, supermarkets and factories.

1 Energy-efficient • Comfortable

It adopts DC motor and the compressor's drive program is optimized. The lowest operation frequency is lowered and the compressor's output is decreased, more energy-saving and efficient.

Application of DC inverter compressor

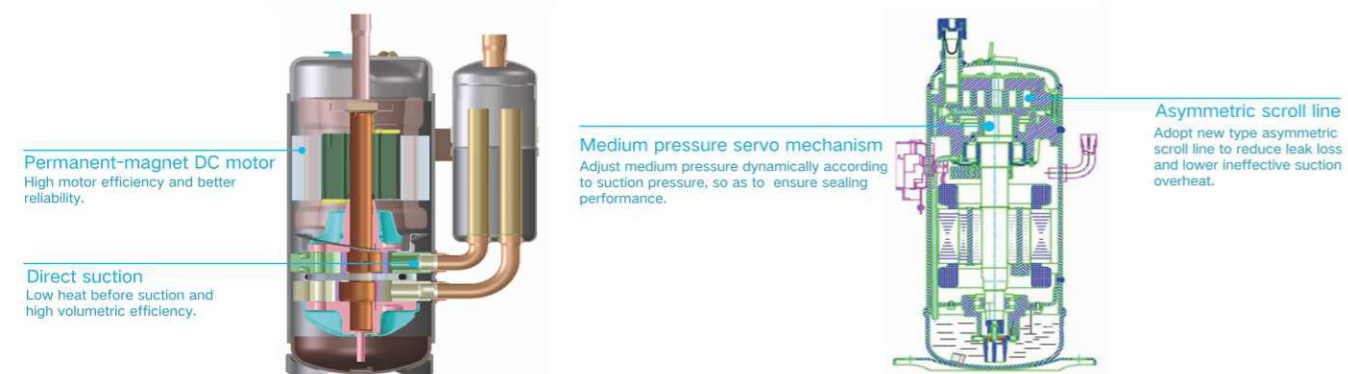

Inverter 180° sine wave technology

» Thanks to inverter 180° sine wave technology, output of compressor is much smoother and fluctuation of temperature is smaller, more energy-saving and comfortable.

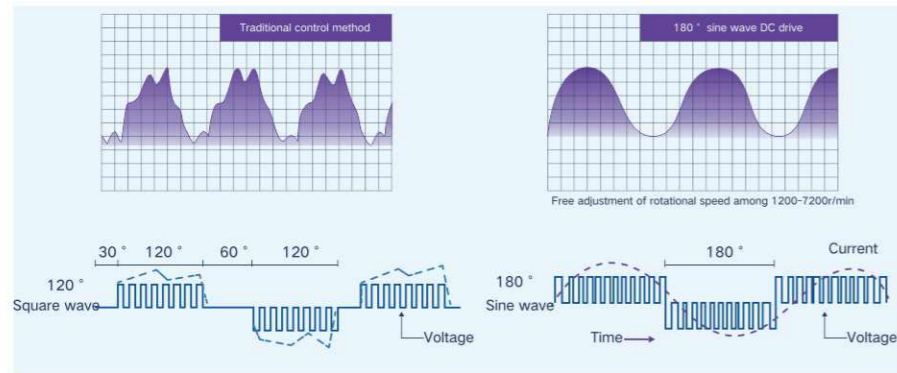

Torque control technology

» Thanks to the minimum current and maximum torque control technology, the minimum current can output the maximum torque, reducing the consumption of motor winding and intelligent power module for higher efficiency.

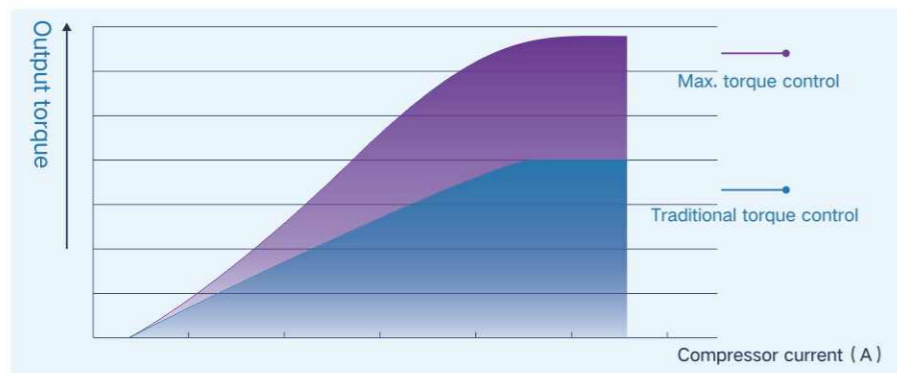

Inverter fan control technology

» DC inverter motor is adopted with reserved outlet air static pressure, energy-saving function and quiet function etc., being able to achieve stepless speed control within 5Hz~75Hz. Stepless inverter fan control is more precise compared with multiple speed adjustment.

» Fan speed is adjusted precisely according to the demand of heat exchange amount, which effectively ensures system pressure maintained in most optimized status and greatly improves motor efficiency.

*Not applicable for 50-60kW fixed-speed units.

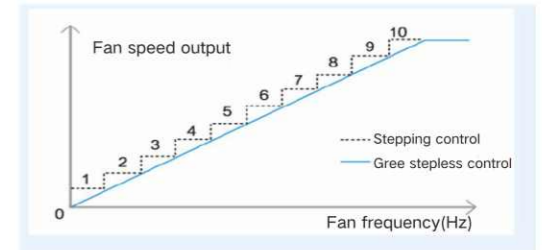

Condenser simulation design

» Condenser adopts fine-draw fins and inner-threaded heat exchange pipe. Through simulation of wind field and stream, condenser heat exchange effect is greatly improved.

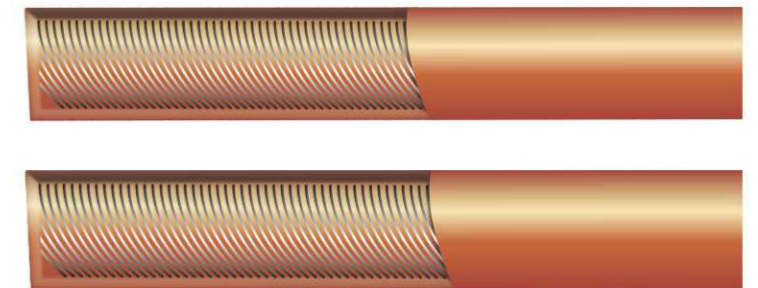

Inner-threaded pipe

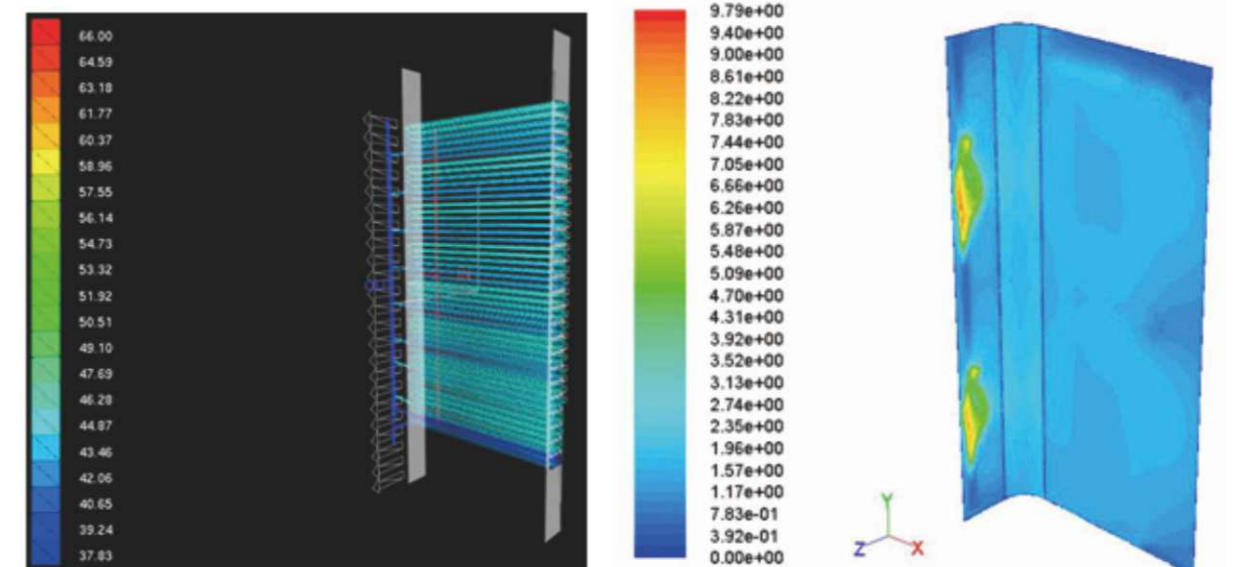

PID control technology

» Adopt smart PID capacity adjustment technology for quickly and accurately reaching set temperature. The comfort in the room is greatly improved thanks to small temperature fluctuation.

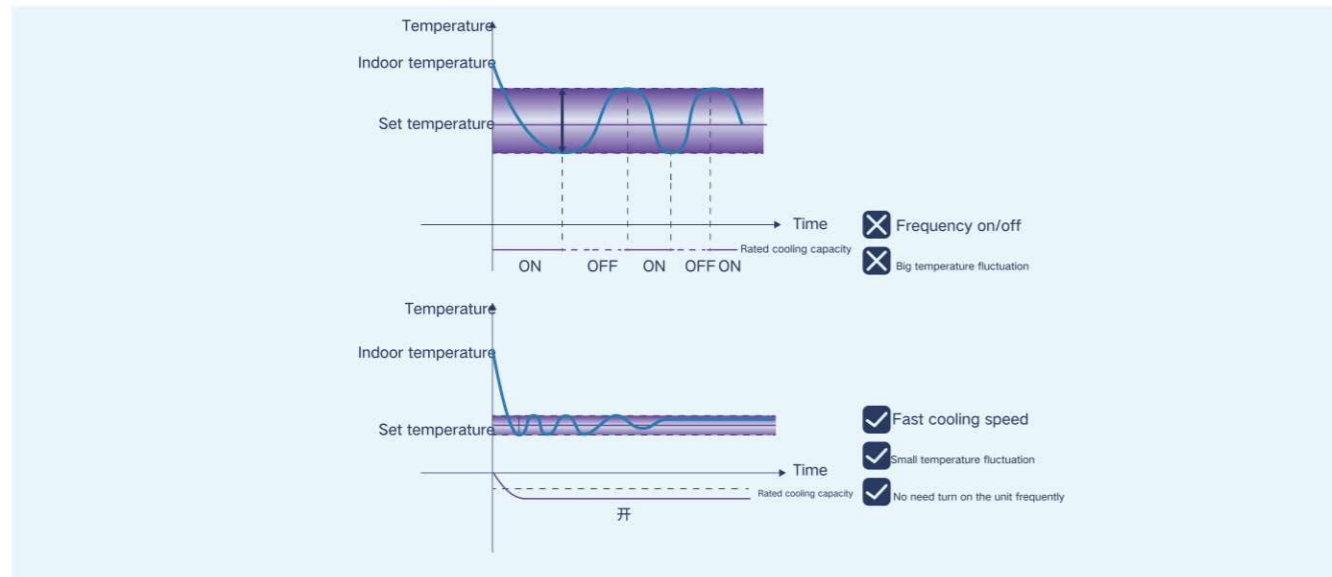

Constant Air Volume • High Static Pressure

High static pressure design

» The air outlet static pressure of unit is up to 250Pa, with further air supply distance, suitable for various places.
 » Users can freely adjust the static pressure among 0~250Pa according to the actual requirements, with high engineering adaptability.

Constant air volume control

» Thanks to automatic constant air volume function, the unit can freely and intelligently adjust the fan for maintaining constant air volume output, convenient and reliable.
 » Constant air volume is controlled by the current of motor.

Smart filth blockage cleaning reminder

» The whole series indoor units have been equipped with filters for filtrating the sundries and hair in the air. The filth blockage of unit can be predicted by monitoring motor current and the change of rotation speed. The wired controller smartly reminds the user for cleaning.

Eco-friendly • Reliable

CAN-Bus communication technology

» Non-polar communication with strong resistance against electromagnetic interference. Specialized shield wire is not needed for communication between units. Common communication wires can be used.



High reliability design of compressor

» Compressor adopts the technology to achieve sufficient oil supply, little abrasion and stable operation.
 » High-efficiency oil separation: Effectively prevent rotary oil return and reduce oil wound up to top of the motor.
 » High-efficiency oil supply: Oil pipe design ensures sufficient oil supply.
 » Non-contact oil film seal: Axial and radial direction of compressor adopts non-contact seal. With oil film seal of lubricant, there is little abrasion.
 » Lubricant cleaning: Impurities generated during running-in period will be absorbed to ensure lubricant cleanness.

Wide Range of Running Temperature

» DC motor is adopted. With precise control on high pressure, temperature range for cooling is wider.

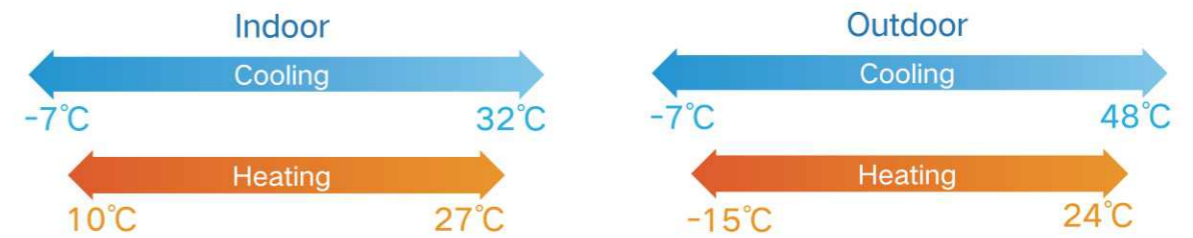

Wide range of operation voltage

» Voltage between 342V~456V is applicable, which can better cope with the voltage fluctuation.



Side Discharge DC Inverter

Maintenance • Convenience

Side discharge casing, convenient for installation

» The size of side discharge casing is smaller and the weight is lighter, which saves space greatly. The floor space will decrease by 30% and loading quantity will increase by 20%;
 » Flexible transportation, move in/out the passenger elevator directly; it can be installed in the wall, convenient for the installation.

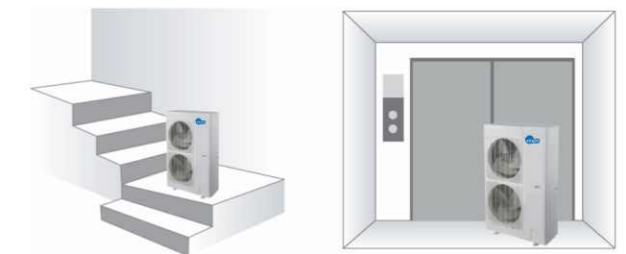

Long connection pipe with big height difference

» Connection pipe between indoor and outdoor units can be as long as 70m; the max allowable height difference between indoor unit and outdoor unit is 30m.

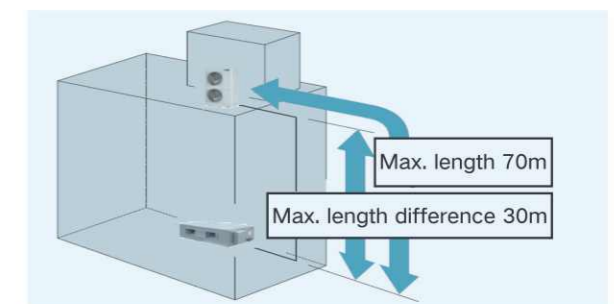

Big Duct Type Unit High Capacity Series



It is a kind of split system that can be connected with air duct to realize cooling/heating in large space.



Intelligent defrosting

Compact design

Comprehensive protection

Easier maintainability

Self-diagnosis

Wide operation range

- » DC inverter for high efficiency and energy saving.
- » High static units for longer ducted runs.
- » ESP is up to 250Pa.*
- » Static pressure is adjustable.
- » Indoor fan can be adjusted according to the static pressure of air duct installed by customers.

*This function is only fit for 20~40kW product models

Item	Nominal operating condition (temperature)				Operating range (temperature)
	Outdoor condition		Indoor condition		
	DB (°C)	WB (°C)	DB (°C)	WB (°C)	Outdoor condition DB (°C)
Cooling	35	24	27	19	-7~48
Heating	7	6	20	15	-15~24

Specifications

Model	Heat pump		JASA-FGR20Pd	JASA-FGR25Pd	JASA-FGR30Pd	JASA-FGR40Pd	
Capacity	Cooling	kW	20	25	30	40	
		Btu/h	68200	85300	102400	136500	
	Heating	kW	22.0	27.5	33.0	43.0	
		Btu/h	75100	93800	112600	146700	
EER/COP		W/W	2.56/3.14	2.65/3.10	2.65/3.20	2.59/3.10	
Power supply		V/Ph/Hz	380-415V 3N-50/60Hz				
Power input	Cooling	kW	7.80	9.44	11.30	15.45	
	Heating	kW	7.00	8.87	10.30	13.85	
Current input	Cooling	A	16.50	18.90	22.70	27.80	
	Heating	A	15.60	17.20	20.70	26.40	
Refrigerant charge volume		kg	6.40	8.00	9.50	6.40x2	
Indoor unit	Airflow volume	CFM	2177	2472	3060	4120	
		m³/h	3700	4200	5200	7000	
	ESP	Rated	Pa	120			
		Range	Pa	0-250			
	Sound pressure level(H/M/L)	dB(A)	52/51/50	53/52/51	55/54/53	56/55/54	
	Dimension (W×D×H)	Outline	mm	1315×760×385	1520×840×450	1520×840×450	1680×900×650
Package		mm	1578×883×472	1788×988×580	1788×988×580	1923×1153×850	
Net weight/Gross weight	kg	82/104	99/134	105/145	165/210		
Outdoor unit	Sound pressure level	dB(A)	62	63	65	62*	
Dimension (W×D×H)	Outline	mm	940×320×1430	940×460×1615	940×460×1615	(940×320×1430)×2	
	Package	mm	1038×438×1580	1038×578×1765	1038×578×1765	(1038×438×1580)×2	
Net weight/Gross weight	kg	120/130	146/162	175/190	(120/130)×2		
Connection pipe	Outer diameter	Liquid	Inch(mm)	Φ3/8(9.52)	Φ3/8(9.52)	Φ1/2(12.7)	Φ3/8(9.52)×2
		Gas	Inch(mm)	Φ3/4(19.05)	Φ7/8(22.2)	Φ1(25.4)	Φ3/4(19.05)×2
	Max. distance	Height	m	30			
		Length	m	70			
Loading quantity	20'GP	unit	15	12	12	6	
	40'GP/40'HQ	unit	35/42	28/28	28/28	12/14	

*Single unit's noise value

Model (Indoor unit/Outdoor unit)			JASA-FGR50Pd	JASA-FGR60Pd	
Capacity	Cooling	kW	50	60	
	Heating	kW	53.0	64.0	
Power supply		V/Ph/Hz	380-415V 3N-50Hz		
Power input	Cooling	kW	21.7	27.0	
	Heating	kW	18.9	20.8	
Current input	Cooling	A	38.8	48.3	
	Heating	A	33.8	37.2	
Refrigerant charge volume		kg	16	19	
Indoor unit	Airflow volume	CFM	5296	6356	
		m³/h	9000	10800	
	ESP	Rated	Pa	160	160
		Range	Pa	-	-
	Sound pressure level	dB(A)	60	62	
	Dimension (W×D×H)	Outline	mm	1900×1100×700	1900×1100×850
Package		mm	2123×1493×900	2123×1493×1055	
Net weight/Gross weight	kg	255/330	270/350		
Outdoor unit	Sound pressure level	dB(A)	63*	65*	
Dimension (W×D×H)	Outline	mm	(940×460×1615)×2	(940×460×1615)×2	
	Package	mm	(1038×578×1765)×2	(1038×578×1765)×2	
Net weight/Gross weight	kg	(155/168)×2	(188/203)×2		
Connection pipe	Outer diameter	Liquid	Inch(mm)	Φ3/8(9.52)×2	Φ1/2(12.7)×2
		Gas	Inch(mm)	Φ7/8(22.2)×2	Φ1(25.4)×2
Max. distance	Height	m	30	30	
	Length	m	70	70	
Loading quantity	20'GP	unit	4	4	
	40'GP/40'HQ	unit	10/10	10/10	

Control System Lineup

Control system	Product series	Duct split unit
Wired controller	JASA-XK46 	●
	JASA-XE7A-24/H 	○
	JASA-XE70-33/H 	○
	JASA-JS13 	○
	JASA-LE60-24/H1 	○
Remote controller	JASA-YAP1F 	○
MODBUS gateway	JASA-ME30-24 	○
Centralized controller (up to 36 indoor units)	JASA-CE52-24/F 	○

Note:
● means standard, ○ means optional. Smart zone controller should be selected with the wired controller at the same time.



Air-cooled Packaged Unit

10HP big cooling capacity and 4000m³/h circulation air volume for turbo cooling and heating, applicable for office buildings, meeting rooms, hospitals, shopping malls, restaurants, hotels and supermarkets.

1 Exquisite technique makes comfort ubiquitous

DC inverter technology, comfortable and energy-saving

» Adopt DC inverter scroll compressor, with higher compression efficiency and wider operation frequency range.

» By adopting DC inverter fan, the efficiency is higher, the noise is lower and the control precision for stepless speed regulation is higher. Cooling is available under the ambient temperature range of -5°C ~ 52°C.

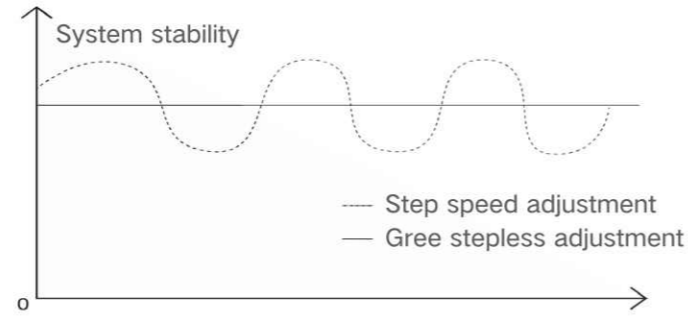

Unique fan design for the optimal heat exchange

» Adopt a brand new fan design and unique installation method for motor, which enhances fan efficiency and heat exchange effect, effect. At the same time, fan vibration will be decreased and the comfort will be improved.

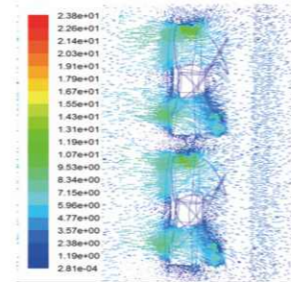

Condenser simulation design for the optimal heat exchange

» Condenser adopts fine-draw fins and inner-threaded heat exchange pipe. Through simulation of wind field and stream, condenser heat exchange effect is greatly improved.

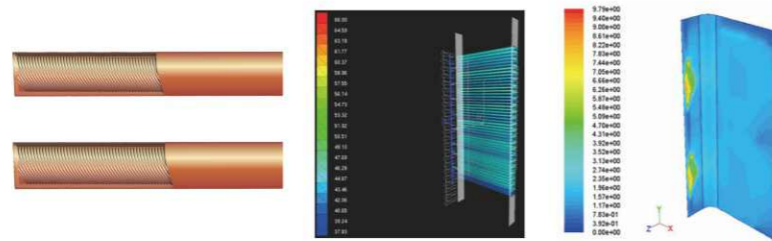

Wide-angle air supply, comfortable everywhere

» Adopt wide air flow design and adopt high-efficiency centrifugal blades for wide-angle and long-distance air supply, creating natural and comfortable indoor environment.

Refreshing appearance, fashionable and versatile

» Depth of slim indoor unit is as low as 0.4M for small occupation space, with black and white colors, fashionable and concise.



Smart design for comfort

» Power-off memory function: Once power failure occurs during operation, the controller can memorize the operation status before power failure. When power recovered, the unit operates under the set modes before power failure.

» 24h timer ON and timer OFF; set 24h timer ON and timer OFF by the wired controller.

» Smart monitoring: Optional gateway and MODBUS protocol for realizing remote control.

» PID algorithm adjustment: Automatically adjust the frequency according to the difference between room temperature and set temperature. When there's big difference between room temperature and set temperature, turbo heating/cooling will be activated; when room temperature is almost the same as set temperature, output capacity will be decreased to maintain the stability.



2 Excellent quality, more reliable operation

High quality and excellent performance

» The unit adopts high-quality parts for reliable operation



High-efficiency DC inverter compressor with intelligent PID capacity adjustment for quick and accurate control, with small temperature fluctuation.



Adopt DC inverter motor for stable operation, higher efficiency and lower noise

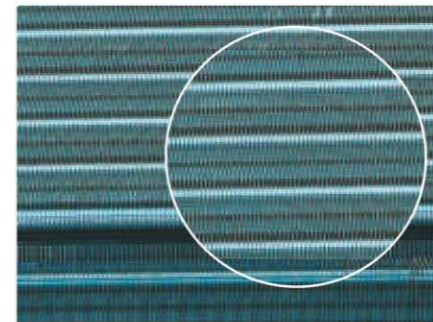

Adopt unique hydrophilic aluminum foil for smoother heat transfer and higher heat efficiency.

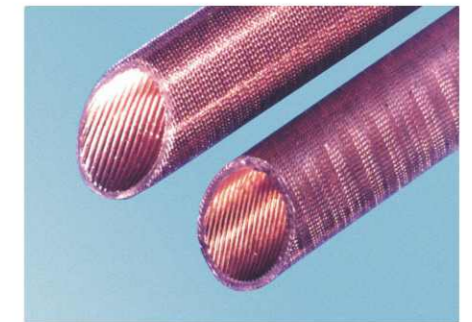

Adopt high-quality seamless inner groove copper pipe for greatly increasing heat exchange efficiency.

Heat dissipation with refrigerant, reliable operation

» Generally, air-cooled fin is adopted for the compressor drive board for heat dissipation, but the size of fin is quite big, thus radiation heat loss is limited. Especially when the ambient temperature is high, heat dissipation requirement cannot be fulfilled. The electric component is easy to be damaged.

» By adopting refrigerant cooling drive board mode, the size will decrease 30%, thus ensuring reliable operation of compressor when ambient temperature is 52°C.

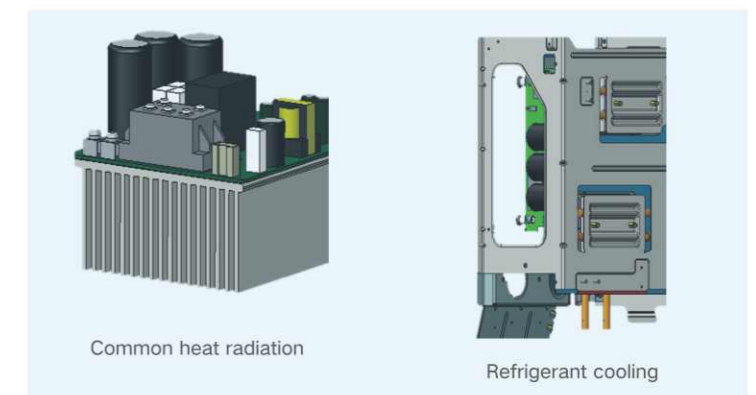

Wide operation range (-15°C to 52°C)

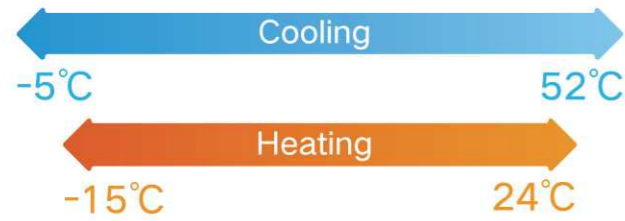

Voltage range for operation is wider, safe and reliable

» The designed air-cooled unit of 96,000 Btu/h can keep stable operation under wider voltage range (342V-456V), thus ensuring the safety of the unit and the staff.



3 Humanized design, convenient for installation

Side discharge casing, convenient for installation

» The size of side discharge casing is smaller and the weight is lighter, which saves space greatly. The floor space will decrease by 30% and loading quantity will increase by 20%;

» Flexible transportation: it can be moved in or moved out of the passage elevator. It can be installed in the wall, convenient for installation.

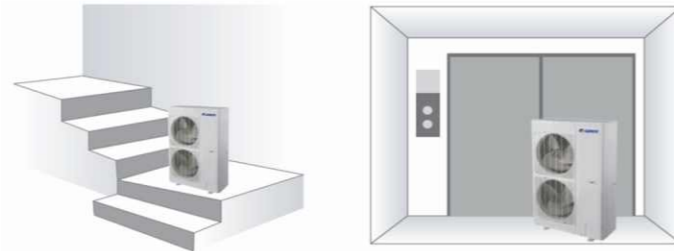

Long pipes design, several installation choices

» The length of the pipe which connects IDU and ODU is 50m, and the max design fall is 30m, providing several installation choices for the user.

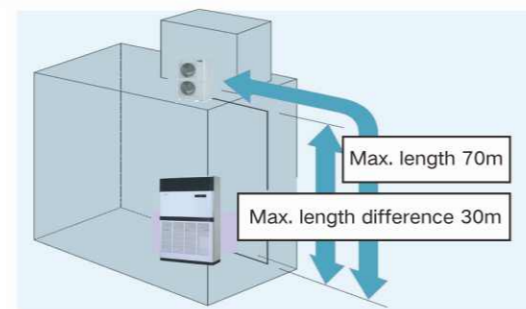

» Thanks to flexible mounting base and 5-way outlet pipe design, installation difficulty and labor cost are greatly decreased.

» Size of inverter outdoor unit is smaller, reducing 40% of floor space compared with the fixed-speed unit;

» Adopt new generation communication protocol; wiring between indoor unit and outdoor unit is simplified; you can select the power cord according to the requirement for communication.



Air-cooled packaged Unit



It is widely applicable to public places such as shopping malls, restaurants, ball rooms, meeting rooms, supermarkets, etc., creating a comfortable and pleasant environment for you.

- » DC inverter technology, comfortable and energy-saving.
- » Side discharge casing, convenient for installation.
- » Adopt drive board heat dissipation with refrigerant for reliable operation.
- » Long pipes design; with several installation choices.
- » Wide operation range.
- » Wider voltage range for operation, safe and reliable.
- » Unique fan design for the optimal heat exchange.

Item	Nominal operating condition (temperature)			
	Outdoor condition		Indoor condition	
	DB(°C)	WB(°C)	DB(°C)	WB(°C)
Cooling	35	24	27	19
Heating	7	6	20	15

Model			JASA-FI-H96A5/AL		
Nominal Capacity	Cooling	Btu/h	96000		
		kW	28.1		
	Heating	Btu/h	102000		
		kW	30.0		
EER/COP	W/W	2.44/3.00			
Electrical Data	Power supply	V/Ph/Hz	380-415V 3N~50Hz		
		Power input	kW	11.5	
	Rated power input	kW	15.4		
	Input current	Cooling	A	19.3	
		Heating	A	24.6	
	Rated current	A	24.6		
	Max .overcurrent protection	A	25		
	Min/Max voltage	Min/Max voltage(V)	V	342/456	
Power cord spec	Electrical conduit size(Inch)	mm ² xpcs	ODU: 2.5 IDU:1.5 x ODU:5 IDU:3		
Refrigerant	Type		R410A		
	Charge	kg	8.00		
Airflow volume		CFM	2354.00		
Outdoor quantity		m ² /h	4000		
		unit	1		
Indoor unit	Sound pressure level	dB (A)	63/60/57		
	Sound power level	dB (A)	73/70/67		
	System operation control		Display panel		
	Dimension(W x D x H)	outline	mm	1200 x 400 x 1850	
		Package	mm	1363 x 513 x 2013	
	Net Weight/Gross weight	kg	129/141		
Outdoor unit	Sound pressure level	dB (A)	63		
	Sound power level	dB (A)	73		
	Dimension(W x D x H)	outline	mm	940 x 460 x 1615	
		Package	mm	1038 x 578 x 1765	
Net Weight/Gross weight	kg	160/174			
Loading quantity	20'GP	set	22		
	40'GP/40'HQ	set	46/46		
Connetion pipe	Length	m	7.50		
	Gas additional charge	g/m	54.00		
	Outer diameter	mm	Φ9.52		
		mm	Φ22.2		
	Max. distance	m	30.00		
		m	50.00		

Control System Lineup

Control system		Product series	Duct split unit
Wireless remote controller	JASA-YAP1F		○
MODBUS gateway	JASA-ME30-24		○
Centralized controller (up to 36 indoor units)	JASA-CE52-24/F		○

Note:
● means standard, ○ means optional.



Local Reference Projects



01 PROJECT Nedbank, Breda Campus Building

35 sets Rooftop Inverter & Large Ducted Inverter
Address :Breda Campus Building
Paarl /Cape Town /South Africa

02 PROJECT Bridge Church Alberton

3 sets Rooftop Inverter
Address :69 – 73 Elizabeth Eybers Street Randhart
Alberton /Johannesburg /South Africa



03 PROJECT Monapo Hospital

28 sets ASI Underceiling Inverter
Address:Mofumahadi Manapo Mopeli Hospital 72 Mampoi
Road,Phuthaditjhaba-A
Phuthaditjhaba /Free State /South Africa

04 PROJECT Tumela Mine,Anglo America

605 sets Q PLUS Inverter
Address : Anglo Operations
Anglo Tumela Mine
Schilpadnest Farm
Amandelbult /Rustenburg /South Africa



05 PROJECT University of Johannesburg

164 sets J-Smart
Address :Maropeng Building Doornfontein Campus 55 Beit
Street,Doornfontein
Johannesburg /South Africa